



Owner's Manual

Original Instructions

Wired Controller ZF93511CJ



Gree+

Thank you for choosing this product. Please read this Owner's Manual carefully before operation and retain it for future reference.

If you have lost the Owner's Manual, please contact the local agent or visit www.gree.com or send an email to global@cn.gree.com for the electronic version.

GREE ELECTRIC APPLIANCES, INC. OF ZHUHAI

To Users

Thank you for selecting Gree product. Please read this instruction manual carefully before installing and using the product, so as to master and correctly use the product. In order to guide you to correctly install and use our product and achieve expected operating effect, we hereby instruct as below:

- (1) This appliance is not intended for use by persons (including children) with reduced physical, sensory or mental capabilities, or lack of experience and knowledge, unless they have been given supervision or instruction concerning use of the appliance by a person responsible for their safety. Children should be supervised to ensure that they do not play with the appliance.
- (2) This instruction manual is a universal manual; some functions are only applicable to particular product. All the illustrations and information in the instruction manual are only for reference, and control interface should be subject to actual operation.
- (3) In order to make the product better, we will continuously conduct improvement and innovation. If there is adjustment in the product, please subject to actual product.
- (4) If the product needs to be installed, moved or maintained, please contact our designated dealer or local service center for professional support. Users should not disassemble or maintain the unit by themselves, otherwise it may cause relative damage, and our company will bear no responsibilities.
- (5) Hereby, our company, declares that this product is in compliance with the essential requirement and other relevant provisions of RE Directive 2014/53/EU. Wireless frequency range:2412MHz – 2472MHz. Maximum Transmit Power:18dBm.

Contents

1 Safety Notices (Please be sure to abide)	1
2 Display	2
2.1 Appearance of Wired Controller	2
2.2 LCD Display and Description	3
3 Operating Modes	5
4 Functions	5
5 Instruction for Operation	7
5.1 ON/OFF	7
5.2 Boost Mode Setting.....	7
5.3 Temperature Setting.....	8
5.4 Timer Setting.....	8
5.5 Setting of Functions	13
5.6 WiFi Function Setting	18
5.7 Other Functions	19
5.8 Reset to Ex-Factory Setting	24
6 Display of Energy Consumption	25
7 Error Display	27
8 Installation and Engineering Commissioning of Wired Controller	28
8.1 Installation of Wired Controller	33
8.2 Requirement for Installation Location	33

1 Safety Notices (Please be sure to abide)



WARNING: If not abide them strictly, it may cause severe damage to the unit or the people.



NOTE: If not abide them strictly, it may cause slight or medium damage to the unit or the people.



This sign indicates that the items must be prohibited. Improper operation may cause severe damage or death to people.



This sign indicates that the items must be observed. Improper operation may cause damage to people or property.



WARNING!

This product can't be installed at corrosive, inflammable or explosive environment or the place with special requirements, such as kitchen. Otherwise, it will affect the normal operation or shorten the service life of the unit, or even cause fire hazard or serious injury. As for the above special places, please adopt special air conditioner with anti-corrosive or anti-explosion function.

2 Display

2.1 Appearance of Wired Controller

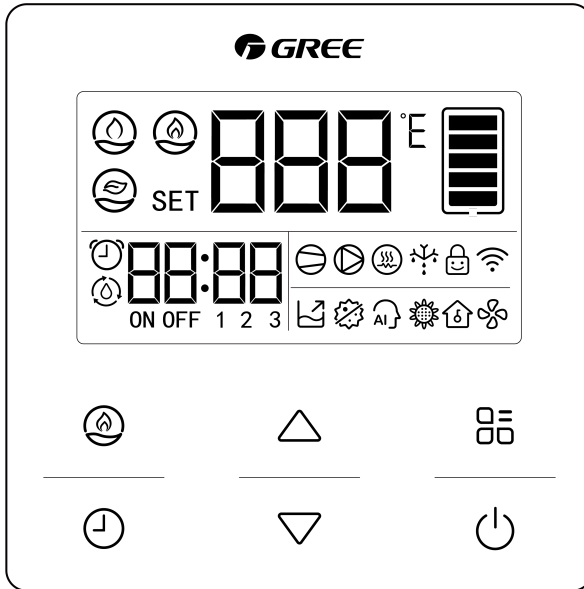

Fig. 2-1 Appearance of Wired Controller

2.2 LCD Display and Description

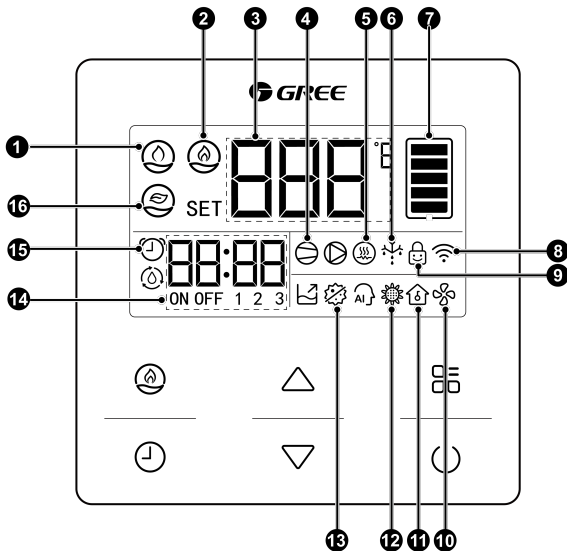















Fig. 2-2 LCD Display of Wired Controller

Table 2.2.1 LCD Display Description

No.	Symbols	Instructions
1		Auto water heating
2		BOOST function icon
3		Temperature area

No.	Symbols	Instructions
4		Operating status of compressor
5		Operating status of auxiliary electric heating
6		Defrosting status
7		Hot water amount
8		WiFi status
9		Child lock
10		Ventilation
11		Holiday
12		Sunflower
13		Sterilization
14		Timer area
15		Timer ON/OFF icon
16		Timer ECO icon(Some units do not support this function)

NOTE: When wired controller is connected with different indoor units, some functions will be different.

3 Operating Modes

Table 3.1 Operation Modes Description

Name	Description
BOOST mode	Applicable for the unit with auxiliary electric heating function or some inverter units, which can shorten the heating operation time and heat up the water quickly.

4 Functions

Table 4.1 Functions Description

Name	Introduction
Timer on/off	To set timer on and timer off time, the unit will operate in the set period. After setting, the unit will operate circularly every day.
Timer ECO	Set the timer ECO time, the unit will operate in ECO mode in the set period. After setting, the unit will operate circularly every day.
Sterilization	The unit can heat the water temperature to 70°C/158°F for the highest installed temperature to kill the Legion bacteria at high temperature. (Some units do not support this function)

Name	Introduction
Sunflower	The higher the ambient temperature is, the easier can the water heater absorb heat from ambient temperature, and the more energy-saving for heating will be. After sunflower function is activated, the water heater will heat up water in the period with relative higher ambient temperature of the day. In other period, it will heat up to medium water temperature at most. Compared to heating in relatively low ambient temperature, it is more energy-saving. It is recommended to activate this function for using only one tank of hot water in one day. After setting, it will conduct everyday circularly.
Holiday	After setting the days of holiday, it will preheat the water before you come back home. During the holiday, the water heater is in standby status. After the holiday ends, it will automatically end the function.
Ventilation	After the compressor stops, the fan keeps running to ensure normal ventilation inside the unit.
WiFi	Can control wired controller via smart App.

Note: Medium water temperature is generally 40°C, which is subject to the unit.

5 Instruction for Operation

5.1 ON/OFF

Press “” button to start up auto water heating function. Press the button again can turn off the unit and stop the water heating function. ON state and OFF state interface of the unit are shown as below:

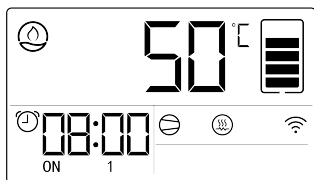

Fig. 5-1 ON State Interface

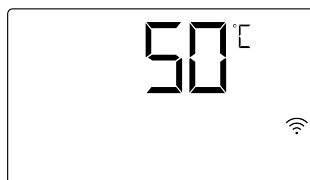



Fig. 5-2 OFF State Interface

5.2 Boost Mode Setting

In the ON state interface, each time press the “” button for once, the BOOST mode can be turned on or turned off.

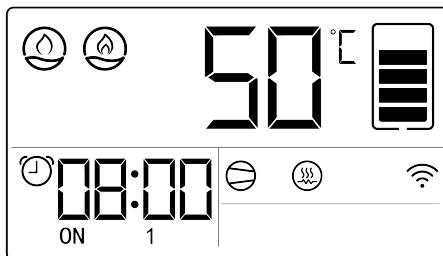



Fig. 5-3 Turn on BOOST mode

5.3 Temperature Setting

In the ON state, press “” or “” button, the set temperature will increase or decrease for 1 degree Celsius or Fahrenheit; when press and hold the buttons, the set temperature will increase or decrease automatically for 1 degree Celsius or Fahrenheit in every 0.3 second.

The settable highest temperature of different modes is different. For the settable water temperature range of each unit shall refer to actual unit.

5.4 Timer Setting

5.4.1 Setting of System Time







- (1) Press “” button, the hour of clock icon flashes, press “” or “” button can adjust the hour.
- (2) Press “” button again, the minute of clock icon flashes, press “” or “” button can adjust the minute.
- (3) After connecting “Gree+” App, the system time will be subject to the time of “Gree+” App, and the system time cannot be set.
- (4) After setting the “Timer ON/OFF” or “Timer ECO”, the system time and timer on time, timer off time are displayed by polling, as shown in Fig. 5-5.
- (5) During setting, press “” button or no button operation for 20 seconds, it will automatically return to the homepage and the setting system time is done.



Fig.5-4 Setting of system time

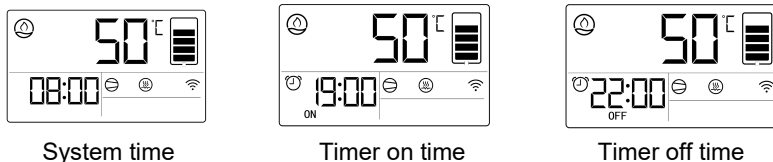









Fig.5-5 Time display

5.4.2 Timer ON/OFF Setting

- (1) Press “” button to enter setting interface of system time, after the system time is set, press “” button to enter timer ON/OFF setting interface, the temperature area “ON” or “OFF” are flashing, press “” or “” button can set timer ON/OFF, when it displays “ON”, it refers timer ON is activated; when it displays “OFF”, it refers the timer setting is off.
- (2) Press “” button again, set the timer ON hour, “” and “ON” icons are constantly on, and timer ON hour icon flashes, press “” or “” button to adjust timer ON hour.





















- (3) Press “” button again, set the timer ON minute, “” and “ON” icons are constantly on, and timer ON minute icon flashes, press “” or “” button to adjust timer ON minute.
- (4) Press “” button again, set the timer OFF hour, “” and “OFF” icons are constantly on, and press “” or “” button to adjust timer OFF hour.
- (5) Press “” button again, set the timer OFF minute, “” and “OFF” icons are constantly on, and press “” or “” button to adjust timer OFF minute;
- (6) During setting, press “” button or no button operation for 20 seconds, it will automatically return to the homepage and the setting of timer ON/OFF time is done.



Fig.5-6 Setting of timer ON/OFF time







5.4.3 Multistep Timer Setting









- (1) In ON or OFF status, or setting interface of system time, press and hold “” button for 5 seconds to enter setting of multistep timer ON/OFF function.

- (2) Press “” button again, the icons status will switch in timer ON/OFF 1, timer ON/OFF 2.
- (3) In timer ON/OFF 1 interface, “” and “ON” and “1” icons are constantly on, press “” button can set the ON/OFF time of timer ON/OFF 1, for setting methods please see “Timer ON/OFF setting”.
- (4) In timer ON/OFF 2 interface, “” and “ON” and “2” icons are constantly on, press “” button can set the ON/OFF time of timer ON/OFF 2, for setting methods please see “Timer ON/OFF setting”.
- (5) During setting, press “” button or no button operation for 20 seconds, it will automatically return to the homepage and the setting of timer is done.

5.4.4 Weekly Timer Setting

Switch timer ON/OFF 2 as weekly timer, for setting method please see the setting of Timer 2 type in “Special parameters setting”.

- (1) Press and hold “” button, switch to setting interface of timer ON/OFF 2 according to “Multistep timer setting”, then it is weekly timer setting.
- (2) “ON” or “OFF” in temperature area are flashing, press “” or “” buttons to set on and off of weekly timer, when it displays “ON”, the weekly timer is activated, when it displays “OFF”, the weekly timer is turned off.
- (3) Press “” button again, “” and “2” icons are constantly on, “d:XX” is flashing, it refers to what day of the week currently. Press “” or “” button can adjust the time. After connecting “Gree+” App, the system time will be subject to the time of “Gree+” App, and the system time cannot be set.

- (4) Press “” button again, “” and “2” and “ON” icons are constantly on, “d:XX” is flashing, it refers to it will turn on in what day of the week, Press “” or “” button can adjust the weekly timer ON time.
- (5) Press “” button again, “” and “2” and “OFF” icons are constantly on, “d:XX” is flashing, press “” or “” button can adjust the weekly timer OFF time.
- (6) During setting, press “” button or no button operation for 20 seconds, it will automatically return to the homepage and the setting of timer is done.
- (7) The following shows the current time, ON time, OFF time of weekly timer setting.



Which day of a week

Weekly timer start time

Weekly timer end time

Fig.5-7 Display of weekly timer

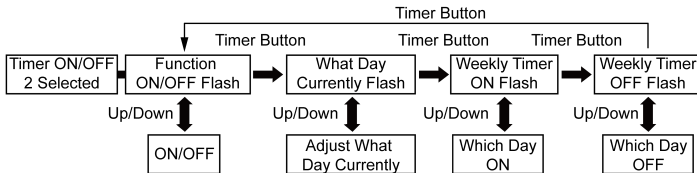















Fig.5-8 Setting steps of weekly timer

5.5 Setting of Functions

- (1) In power-on interface, press  button to enter the function selection interface, and then press  button to switch among timer ECO1, timer ECO2, sterilization, sunflower, holiday, ventilation; when setting corresponding function, the corresponding icon will turn on.
- (2) In power-off interface, press  button can enter the function selection interface. In the power-off status, only ventilation function can be set.
- (3) Holiday function is conflicting with timer and weekly timer functions. If either one of the functions is activated, the other function would be canceled automatically.
- (4) Some functions above are only available for specific unit, please subject to actual product.

5.5.1 Timer ECO Setting

- (1) Press  button to enter setting interface of timer ECO1, then timer ECO  and "SET" is constantly on, "ON" or "OFF" in temperature area are flashing, press  or  button to set ON/OFF of timer ECO function. When it displays "ON" it refers to the timer ECO function is activated, when it displays "OFF" it refers to the timer ECO function is turned off.
- (2) Press  button again, set the timer ON hour of ECO function,  and "ON" icons are constantly on, and timer ECO hour icon flashes, press  or  button to adjust timer ON hour of ECO function.
- (3) Press  button again, set the timer ON minute of ECO function, 

and “ON” icons are constantly on, and timer ECO minute icon flashes, press “△” or “▽” button to adjust timer ON minute of ECO function.

- (4) Press “J” button again, set the timer OFF hour of ECO function, “⌚” and “OFF” icons are constantly on, and press “△” or “▽” button to adjust timer OFF hour of ECO function.
- (5) Press “J” button again, set the timer OFF minute of ECO function, “⌚” and “OFF” icons are constantly on, press “△” or “▽” button to adjust timer OFF minute of ECO function.
- (6) Press “□□” again to enter timer the setting interface of ECO2 function, the setting method is the same as that of setting timer ECO1, please subject to the above setting steps (1)~(5).
- (7) Timer ECO function is not available for some units, please refer to the actual product. The timer ECO function of some units can only be set on the “Gree+” App. If necessary, please connect to the “Gree+” App.
- (8) During setting, press “⌚” button or no button operation for 20 seconds, it will automatically return to the homepage and the setting of timer ECO timer is done.

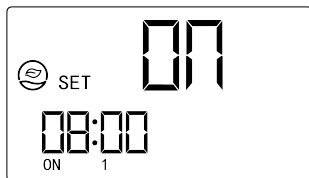

Fig.5-9 Setting of timer ECO time

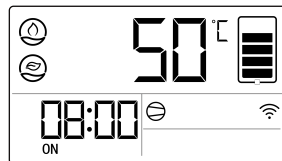













Fig.5-10 Start interface of timer ECO function

5.5.2 Setting of sterilization time

- (1) Press " to enter the setting interface of sterilization, and then the sterilization icon " and setting icon "SET" are constantly on.
- (2) "ON" or "OFF" in temperature area are flashing, press " or " button to set ON/OFF of sterilization function. When it displays "ON" it refers to sterilization is activated, when it displays "OFF" it refers to the sterilization function is turned off, when "ON" or "OFF" icon flickers, sterilization interface "d XX" display the rest days of sterilization.
- (3) Press " button, and then "sterilization cycle" flickers, press " or "
- (4) Button to adjust sterilization cycle, then "d XX" displays the sterilization cycle.
- (5) Press " button again, the "sterilization start time" flickers, press " or "
- (6) When conducting sterilization, the sterilization icon " flickers in main interface.
- (7) During setting, press " button or if there is no button operation for 20 seconds, it will automatically return to main interface and complete the setting of sterilization time.

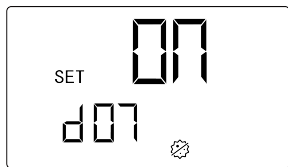

Fig.5-11 Display of sterilization cycle









Fig.5-12 Display of sterilization start time

Notes:

- ① Sterilization cycle: The setting value means the sterilization will be conducted how many days once.
- ② When the sterilization cycle is set as 0, it will conduct sterilization immediately and shield the setting of start time.
- ③ Sterilization time should be set within the timer ON time, otherwise the sterilization function will fail.
- ④ Enter sterilization setting interface, when “ON” or “OFF” flickers, it displays the rest days of sterilization.

5.5.3 Setting of holiday time

- (1) Press “” to enter holiday setting interface, the holiday icon “” and setting icon “SET” are on.
- (2) Press “” button, “days of holiday” flickers, press “” or “” button can adjust the days of holiday;
- (3) After setting the holiday, back to the main interface, it will display the rest days of holiday and holiday icon.
- (4) During setting, press “” button or if there is no button operation for 20 seconds, it will automatically return to main interface and complete the

setting of holiday time.

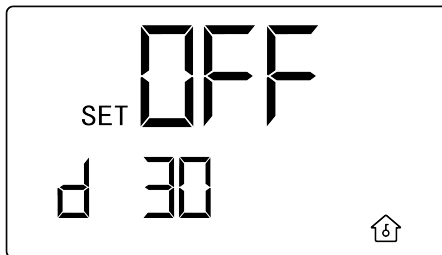

Fig. 5-13 Setting of holiday time

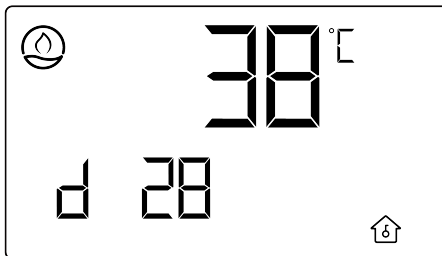

Fig. 5-14 Display of main interface after setting holiday

Notes:

- ① After activating holiday mode, turn off the unit can quit the holiday function.
- ② After activating holiday mode for 1 hour, you can operate the set temperature, turn on and off the BOOST function, or quit the holiday function.

5.5.4 Setting of Sunflower and Ventilation Functions





- (1) Press “” to enter function setting interface.
- (2) When setting sunflower function, the sunflower icon “” and setting icon “SET” are on.
- (3) When setting ventilation function, the ventilation icon “” and setting icon “SET” are on.
- (4) “ON” or “OFF” in temperature area are flicker, press “” or “” button can turn on or turn off related function.



Fig. 5-15 Sunflower function is on

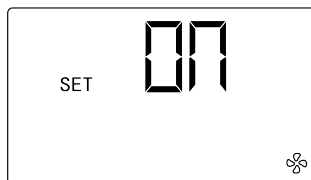



Fig. 5-16 Ventilation function is on



5.6 WiFi Function Setting

You can use “Gree+” App to control it, please scan the QR code in the home page to download it.

Only common functions of WiFi wired controller can be set through App: ON/OFF, Boost mode, set temperature, timer ON/OFF, timer ECO, holiday, sterilization, and can view the information of power consumption, heat production and COP.





If you use the App for the first time, please reset WiFi at first (restore ex-factory setting for WiFi).

When the wired controller is ON/OFF, long press “ + “” buttons for 5 seconds, the prompting sound will occur 3 times and the wired controller will display “YES” for 5 seconds, WiFi reset is successful.

If there's WiFi communication error, after long press “ + “” buttons for 5 seconds, the prompting sound will occur 2 times and the wired controller will display “JF” for 5 seconds, the current reset is invalid.

5.7 Other Functions

5.7.1 Child Lock Function

In the ON state or OFF state without error, press “” and “” buttons simultaneously for 5 seconds, the wired controller will enter into child lock function, the LCD will display “”; press “” and “” buttons simultaneously for 5 seconds again can quit the child lock function.

Under child lock status, there will be no response for pressing other buttons. If the function is set before power failure, after re-energizing the unit, the unit will still in child lock mode.

5.7.2 SG Function

- (1) SG01 state: the unit keeps off and will not conduct heating (except necessary anti-freeze demand), you can set the ON and OFF of SG01 in special parameter setting to enable the default ON state of SG01. After the

SG01 is off, the state of SG01 will operate according to the state of SG02.

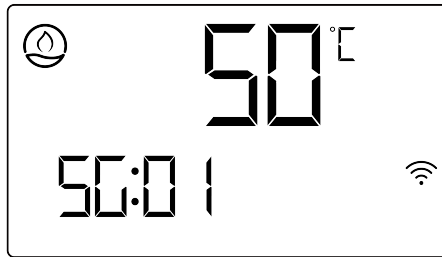

Fig.5-17 SG01 display

- (2) SG02 state: normal operation of unit.
- (3) SG03 state: it conducts heating control at a set value which is relatively higher than normal set temperature. When in SG03 state, the set temperature of SG03 state can be adjusted.

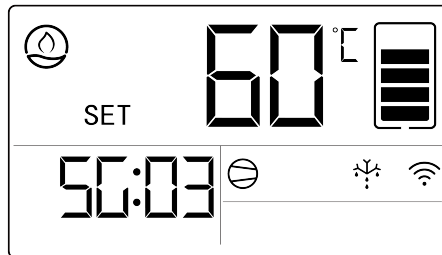

Fig.5-18 Display of SG03

- (4) SG04 state: it conducts heating control at a set value which is higher than

the set temperature of SG03 state. When in SG04 state, the set temperature of SG04 state can be adjusted.

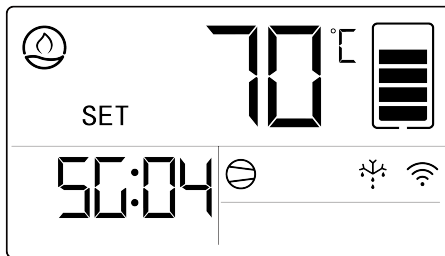

Fig.5-19 Display of SG04

5.7.3 Special Parameters Setting

- (1) In ON or OFF state interface, press and hold “” + “” buttons for 5 seconds, temperature area displays “00”.
- (2) When the system parameters inquiry interface is “00”, press and hold “” + “” buttons for 5 seconds, temperature area displays “E00”.
- (3) When the engineering parameters interface is “E00”, press and hold “” + “” buttons for 5 seconds, temperature area displays “F00”.
- (4) Press “” or “” button can adjust the value of special parameters;
- (5) Press “” button to select special parameters value.
- (6) Press “” or “” buttons to adjust the parameter option “01” or “00” of special parameter value.
- (7) Press “” button to confirm the parameter option, then the setting is done.

Table 5.7.1 Instruction for Special Parameters

Special Parameters	Special Parameter Value	Parameter Option	Instruction	Remarks
ON/OFF memory after power failure	E01	01	ON/OFF memory after power failure	Settable in both ON and OFF states
		00	No ON/OFF memory after power failure	
Temperature display transition Setting	E02	01	Fahrenheit (°F)	Settable in both ON and OFF states
		00	Celsius (°C)	
Electric heating enabling	E03	00	OFF	Settable in both ON and OFF states
		01	ON	
Resume to Ex-factory Setting	E12	01	Resuming to ex-factory setting of wired controller is on	Settable in OFF states
		00	Resuming to ex-factory setting of wired controller is off	

Wired Controller ZF93511CJ

Special Parameters	Special Parameter Value	Parameter Option	Instruction	Remarks
Timer 2 type	E16	00	Timer ON/OFF 2 displays that 24:00 is clock timer	Settable in both ON and OFF states
		01	Timer ON/OFF 2 displays that 07:01 is weekly timer	
Holiday temperature	E21	Adjust within the range of 2~60°C		Settable in both ON and OFF states
SG01 enabling	E22	00	OFF	Settable in both ON and OFF states
		01	ON	
Fan speed compensation	E26	Adjust within the range of 0~6		Settable in both ON and OFF states
Ventilation fan speed	E27	Adjust within the range of 100~Maximum (The maximum value is based on the actual unit.)		Settable in both ON and OFF states

Special Parameters	Special Parameter Value	Parameter Option	Instruction	Remarks
Function status value	F06	Settable within 0-15		Settable in OFF states
Clear of energy consumption data	F19	00	Not clear	Settable in both ON and OFF states
		01	Clear	

Notes:

- ① Resuming to ex-factory setting is available only in the OFF state.
- ② During the setting, press “” button or no operation for 180 seconds, the unit will automatically quit the setting, and the setting is invalid.
- ③ Except for the aforesaid special parameter setting, other special parameter setting can only be set by installing and debugging personnel, please do not alter by yourself, otherwise it may cause malfunction of unit.

5.8 Reset to Ex-Factory Setting

If the functions of unit cannot work well due to ex-factory setting is altered by misoperation, user can reset to ex-factory setting via wired controller.



Method 1: press and hold “” button for 5 seconds, the unit will resume to ex-factory setting. This operation is only valid for some units.

















Method 2: please set according to “Special Parameters Setting” section.

6 Display of Energy Consumption

This unit can calculate and display energy consumption information through relevant parameters, including power consumption and heat production data. The purpose of collecting relevant energy consumption data is to facilitate users to view the current energy consumption information of the unit through quantifiable data. The relevant energy consumption data needs to be approved by the user through relevant parameter settings before it can be stored inside the unit. If the user needs relevant displays, they can follow the following steps to set them:

- (1) For displaying energy consumption, first set the F06 in the special parameter setting as 03. If energy consumption data does not need to be displayed, set the F06 value to 00 and the unit will not be calculating energy consumption data.
- (2) For engineering parameter F06 settings, please refer to “5.7.3 Special Parameter Setting”.
- (3) If the energy consumption data need to be cleaned out, please set the F19 in the special parameter value as 01, the value of F19 has been restored to 00, indicating successful data deletion, Setting method for F19 parameter value.

① Press “”+“” for 5 seconds, the temperature area will display “00”.

- ② Press “”+“” for 5 seconds, the temperature area will display “E00”.
 - ③ Press “” + “” buttons for 5 seconds, the temperature area will display “F00”, Press “” or “”, the temperature area will display “F19”.
 - ④ Press “” to switch to set parameter value, at this time, “00” in the clock area will flash. Press “” or “” to adjust “01” .
 - ⑤ Press “” for confirmation and complete setting.
- (4) The viewing method is as follows: in ON or OFF state interface, press and hold “” + “” buttons for 5 seconds, temperature area displays “00”.
 - (5) Press “” or “” to adjust to “02”, and press “” to display the energy consumption data. Only specific unit can display the energy consumption, please subject to actual product.
 - (6) In the display interface of energy consumption, press “” or “” can circularly switch among heat production- day, power consumption- day, COP- day, heat production- month, power consumption- month, COP- month, heat production- year, power consumption- year, COP- year.
 - (7) For viewing detailed data of energy consumption, please connect “Gree+” App.

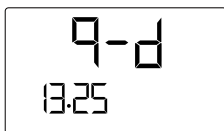

Fig.6-1 Heat Production-day

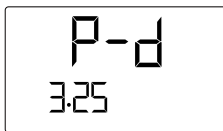

Fig.6-2 Power Consumption-day



Fig.6-3 COP-day

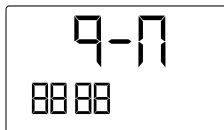

Fig.6-4 Heat production-month



Fig.6-5 Power Consumption-month

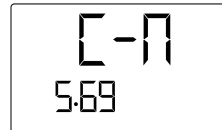

Fig.6-6 COP-month

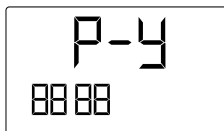

Fig.6-7 Heat Production-year

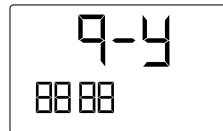

Fig.6-8 Power Consumption-year

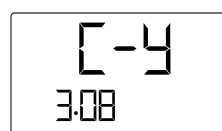

Fig.6-9 COP-year

7 Error Display

When errors occur during the operation of the system, timer display area will display the error code, and the temperature area displays the current water inlet temperature and outlet temperature, please turn off the unit and ask professional to repair.

When error occurs, except for the operation of ON/OFF, special parameter setting, other operations are not available.

If many errors occur simultaneously in the unit, the error codes will be displayed circularly.

The following figure shows communication error.

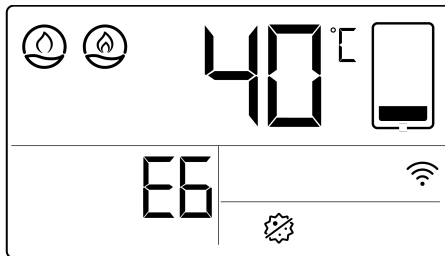

Fig.7-1 Display of error

Table 7.1 List of Errors

Error Code	Error Name	Error Code	Error Name
E1	System high-pressure protection	F4	Air discharge temperature sensor error
E3	System less refrigerant protection/ low-pressure protection	Fd	Inhalation temperature sensor error
E6	Communication error	F6	Outdoor tube temperature sensor error
C5	Jumper cap error	E4	Air discharge protection

Wired Controller ZF93511CJ

Error Code	Error Name	Error Code	Error Name
F3	Outdoor ambient temperature sensor error	L6	Inadequate capacity of unit
Ec	Water flow switch protection	P9	Inverter compressor driver AC input zero-sequence overcurrent protection
EF	Air outlet blockage protection		

Table 7.2 List of Driver Errors

Error Code	Error Name	Error Code	Error Name
EE	EPROM storage chip error	AA	Inverter outdoor fan AC protection (input side)
ee	Inverter compressor driver storage chip error	AC	Inverter outdoor fan startup failure
H5	Inverter compressor driver IPM module protection	Ad	Inverter outdoor fan less phase protection
HC	Inverter compressor driver PFC protection	AE	Inverter outdoor fan driver current detecting circuit error
H7	Inverter compressor out-of-step protection	Ar	Inverter outdoor fan driver electric box temperature sensor error

Error Code	Error Name	Error Code	Error Name
Lc	Inverter compressor startup failure	AL	Inverter outdoor fan driver DC bus low-voltage protection or voltage drop error
Ld	Inverter compressor default phase protection	A8	Inverter outdoor fan driver module high-temperature protection
LF	Inverter compressor power protection	AH	Inverter outdoor fan driver DC bus high-voltage protection
PA	Inverter compressor driver AC protection (input side)	AP	Inverter outdoor fan driver AC input voltage error protection
Pc	Inverter compressor driver current detecting circuit error	AU	Inverter outdoor fan driver charging loop error
PF	Inverter compressor driver electric box temperature sensor error	PP	Inverter compressor driver AC input voltage error protection
PL	Inverter compressor driver DC bus low-voltage protection or voltage drop error	A6	Master controller and inverter outdoor fan driver communication error
A0	Inverter outdoor fan driver module reset	AJ	Inverter outdoor fan out-of-step protection
PU	Inverter compressor driver charging loop error	A9	Inverter outdoor fan driver module temperature sensor error

Wired Controller ZF93511CJ

Error Code	Error Name	Error Code	Error Name
P0	Inverter compressor driver module reset	U9	Inverter outdoor fan driver AC input zero-sequence overcurrent protection
P5	Inverter compressor overcurrent protection	An	Inverter outdoor fan driver storage chip error
P6	Master controller and inverter compressor driver communication error	AF	Inverter outdoor fan driver PFC protection
P7	Inverter compressor driver module temperature sensor error	P8	Inverter compressor driver module high-temperature protection
UL	Inverter outdoor fan overcurrent protection	UP	Inverter fan power protection

8 Installation and Engineering Commissioning of Wired Controller

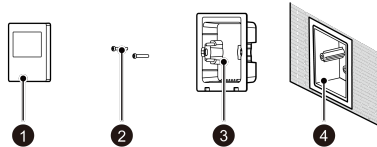
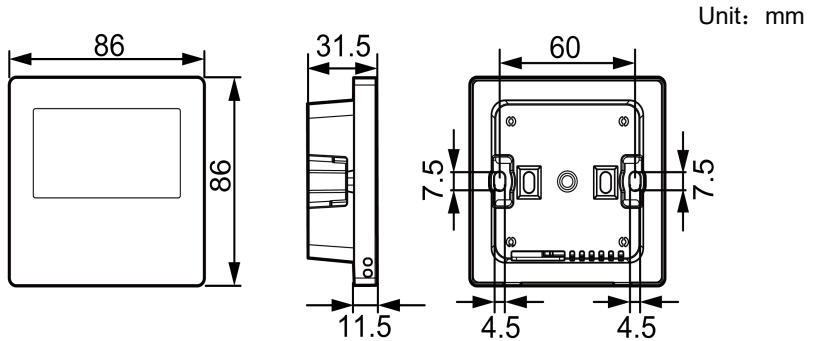

Fig.8-2 Parts and Components of Wired controller

Table 8.1 Parts and Components introduction

No.	①	②	③	④
Name	Wired controller	Screw M4×25	Soleplate of wired controller	Junction box installed inside the wall
QTY	1	2	1	Prepared by user

8.1 Installation of Wired Controller

8.1.1 Instruction of Interface

Table 8.1.1 Instruction of interface

Interface	A/B
Type	485 communication interface (nonpolar)
Parameter	24VDC input

8.2 Requirement for Installation Location

- (1) Please do not install the wired controller in the position where is likely to be spattered with water.
- (2) Please do not install the wired controller near the high-temperature object or under direct sunlight.
- (3) Before installation, please first cut off the power source of heavy current wire embedded inside the installing hole, hot-line work is not allowed during the whole course of the installation.
- (4) In order to prevent malfunction due to electromagnetic interference or related reasons, please pay attention to the following notices:

- 1) Make sure that the interface of communication wire is correctly connected, otherwise it may cause communication error.
- 2) Communication wire of wired controller should be separate with the power cord and outdoor connecting wire, the minimum distance should be over 20cm, otherwise it may cause communication error of unit.
- 3) If the product is installed in the position where is likely to be interfered by electromagnetism, the signal wire of wired controller must adopt STP wire.
- (5) The wired controller should only be installed indoors or in the unit, the working temperature range is $-7^{\circ}\text{C}\sim 45^{\circ}\text{C}$ / $19^{\circ}\text{F}\sim 113^{\circ}\text{F}$.

8.2.1 Indoor Installation

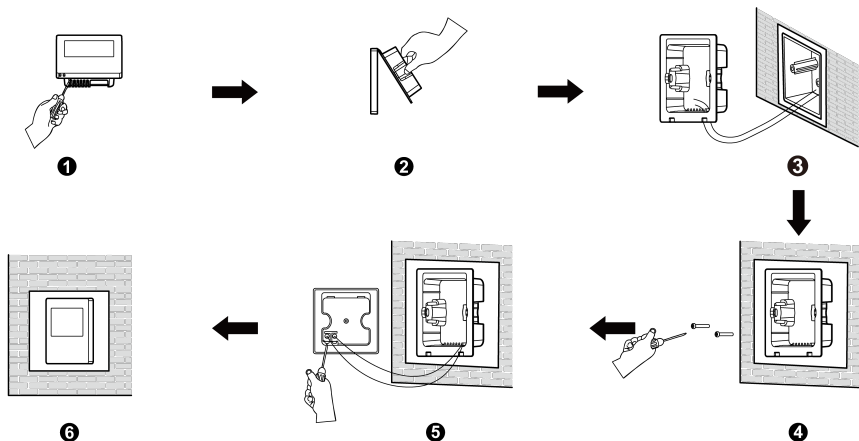

Fig.8-3 Installation of wired controller

The above figure shows the simple installation of wired controller, and the following points should be noted:

- (1) Before installation, please cut off the power source first, hot-line work is not allowed during the whole course of installation.
- (2) Pull out the 2-core STP wire inside the installing hole of wall, and thread the wire through the wire connecting hole in the back of soleplate of wired controller.
- (3) Stick the soleplate of wired controller on the wall, use screw M4×25 to fix the soleplate into the installing hole of wall.
- (4) Connect the 2-core STP wire to the two wiring terminals respectively in the back of wired controller, and screw up the screws.

- (5) Buckle the wired controller panel and wired controller soleplate together, the installation is done.
- (6) The length of the communication cable between the wired controller and the unit can't be more than 8m.

8.2.2 Install in the unit

The wired controller can be directly installed in the unit by installation personnel.

8.2.3 Removal

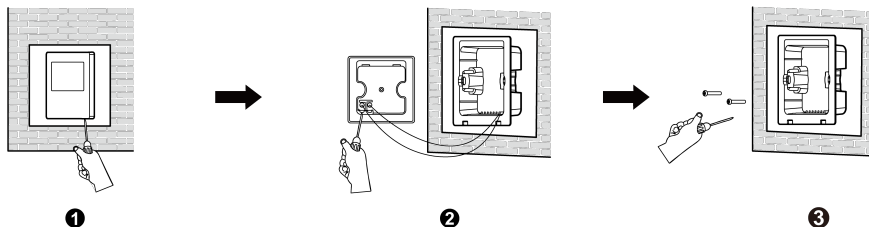

Fig.8-4 Removal of Wired Controller

! Caution!

For removing wired controller in figure ①, please use slot type screwdriver for easily lever the panel and soleplate of wired controller. If the rear cover of wired controller is required to remove, please unscrew the screws of wiring terminals first.



GREE ELECTRIC APPLIANCES, INC. OF ZHUHAI

Add: West Jinji Rd, Qianshan, Zhuhai, Guangdong, China, 519070

Tel: (+86-756) 8522218

Fax: (+86-756) 8669426

E-mail: global@cn.gree.com www.gree.com



600005067599